

**WARRANTY
REGISTRATION**
Register on-line today for
a chance to win a FREE Tripp Lite
product! www.tripplite.com/warranty



Owner's Manual

PowerVerter®

RV Series (v. 3.0)

DC-to-AC Inverter/Chargers



1111 W. 35th Street, Chicago, IL 60609 USA
Customer Support: (773) 869-1234
www.tripplite.com

	Input	Output
Invert:	12 VDC	120V, 60 Hz. AC
Charge:	120V, 60 Hz. AC	12 VDC



Quiet Mobile Power

Congratulations! You've purchased the most advanced, feature-rich Inverter/Charger designed for recreational applications. Tripp Lite RV Inverter/Chargers are the quiet alternative to generators-with no fumes, fuel or noise to deal with! You get AC electricity anywhere and anytime you need it: away from shore power, rolling down the highway, dry camping in majestic back country or overnighting at a non-electric site. Your Tripp Lite Inverter/Charger provides your appliances, equipment and electronics with utility- or generator-supplied AC electricity (filtered through premium ISOBAR® surge protection) whenever available. In addition, it automatically powers your craft's 12V system and recharges your connected battery bank-doing what traditional converter/chargers do. Whenever power blackouts, brownouts or high voltages occur, your Inverter/Charger immediately and automatically switches over to inverting battery output to power connected AC equipment.

Better for Your Equipment

Premium Protection Levels

- Built-In **ISOBAR**® Surge Protection
- Automatic Overload Protection

Ideal Output for All Loads (including computers)

- Frequency-Controlled Output
- Fast Load Switching
- Balanced Load Sharing*

Better for Your Batteries

Faster Battery Recharge

- High-Amp, 3-Stage Battery Charger (adjustable)

Critical Battery Protection

- Battery Charge Conserver (Load Sense)*
- Battery Temperature Sensing*
- High-Efficiency DC-to-AC Inversion

Better for You

Quiet, Simple, Maintenance-Free Operation

- Multi-Function Lights & Switches
- Automatic Generator Starting*
- Moisture-Resistant Construction†

Contents

Specifications/Warranty/Warranty Registration	2	Mounting	10
Safety	3	Battery Connection	11
Feature Identification	4	AC Input/Output Connection	12
Operation	5-6	Service/Maintenance	13
Configuration	6-8	Troubleshooting	13
Battery Selection	9	Français	14

* Available on all models except 612 models. † Inverter/Chargers are moisture-resistant, not waterproof.
Copyright © 2005. PowerVerter® is a registered trademark of Tripp Lite. All rights reserved.

Specifications

MODEL NUMBER:	RV612ULH	RV612ULH	RV1012UL-HW	RV1512UL	RV2012UL	RV2512OEM	RV3012OEM
Series Number:	AGAP60012M/VJ	AGAP100012M/V3	AGAP100012M/V3	AGAP200012M/V3	AGAP200012M/V3	AGAP200012M/V3	AGAP4669
Agency Approvals:	UL458	UL458 with Marine Sup.	UL458	UL458	UL458 with Marine Sup.	UL458	UL458
AC Input Connection:	Input Cord	Input Cord	Hardwire	Hardwire	Hardwire	Hardwire	Hardwire

INVERTER

Common Specifications for All Models: • DC Input Volts (Nominal): 12 VDC • DC Input Voltage Range: 10 - 15 VDC • Output Volts (Nominal): 120 VAC, ± 5% • Output Frequency (Nominal): 60 Hz, ± 0.5% • Efficiency: 88% to 94%, depending on load and temperature
Select Tripp Lite Inverter/Chargers include a Battery Charge Converter (Load Sense) Control which saves battery power by allowing users to set the minimum load level at which the unit's inverter turns on. Users can significantly reduce the No Load DC Input Current (approximately 1 to 3 A for all models) to a very low amp level with the use of this control.

	RV612ULH	RV1012UL-HW	RV1512UL	RV2012UL	RV2512OEM	RV3012OEM
Continuous Power (@ 20°C):	600	1000	1500	2000	2000	2500
OverPower™ Peak Surge Power*:	900	1500	2250	3000	3000	3750
Double Boost™ Peak Surge Power**:	1200	2000	3000	4000	4000	5000
Maximum Output AC Current (Continuous):	5 A	8.3 A	12.5 A	16.7 A	16.7 A	20 A
UL Required DC Fuse and Fuse Block: (or equivalent)	TPN-80 (fuse) R25100-1CR (fuse block) Bussmann (manufacturer)	ANL-200 (fuse) 4164 (fuse block) Bussmann (manufacturer)	ANL-275 (fuse block) 4164 (fuse block) Bussmann (manufacturer)	ANL-200 (fuse) 4164 (fuse block) Bussmann (manufacturer)	ANL-200 (fuse) 4164 (fuse block) Bussmann (manufacturer)	ANL-200 (fuse) 4164 (fuse block) Bussmann (manufacturer)
DC Input Current @ Nominal V DC Full Load:	56 A	95 A	145 A	190 A	190 A	240 A

BATTERY CHARGER

Common Specifications for All Models • Acceptance Volts VDC: Selectable 14.4 V** / 14.2 V Wgt** / Gel • Float Volts DC (w/gel): 13.3 V (13.6 V) • Input Volts (Nominal): 120 VAC
 Charging Capacity DC: 45 A / 11 A**
 Input Current AC: 9.5 A

LINE VAC OPERATION

Common Specifications for All Models • Input Frequency (Nominal): 60 Hz, ± 10% • Maximum Input Volts (Transfer to Battery) (Continuous, Charger at Maximum): Selectable 135** or 145 VAC
 Minimum Input Volts (Transfer to Battery): Selectable 95** or 105 VAC
 Maximum Input AC Current (Continuous, Charger at Maximum): 11.3 A
 Maximum Bypass AC Current (Load circuit breaker limited): 6 A

* OverPower duration (up to 1 hour). DoubleBoost duration (up to 10 seconds). Actual duration depends on battery age, battery charge level and ambient temperature. **Factory setting. The policy of Tripp Lite is one of continuous improvement. Specifications are subject to change without notice. This product designed and engineered in the USA.

Watts	Wire Gauge					
	6	4	2	0	00 (2/0)	Twin 00 (2/0) (RV2012OEM, RV2512OEM & RV3012OEM only)
500	15 ft	25 ft	39 ft	62 ft	79 ft	158 ft
700	11 ft	18 ft	28 ft	44 ft	56 ft	112 ft
1000	N/R	12 ft	20 ft	31 ft	39 ft	78 ft
2000	N/R	N/R	N/R	16 ft	20 ft	40 ft
2400	N/R	N/R	N/R	13 ft	16 ft	32 ft
3000	N/R	N/R	N/R	10 ft	13 ft	26 ft

† N/R = Not Recommended. NOTE: Acceptable power is directly related to cable length (i.e. - the shorter the cable, the better the performance)

Use in conjunction with DC wiring connection instructions in the Battery Connection section.
Inverter/Charger DC Volt: 12

Minimum Recommended Cable Sizing Chart†

Watts	Wire Gauge					
	6	4	2	0	00 (2/0)	Twin 00 (2/0) (RV2012OEM, RV2512OEM & RV3012OEM only)
500	15 ft	25 ft	39 ft	62 ft	79 ft	158 ft
700	11 ft	18 ft	28 ft	44 ft	56 ft	112 ft
1000	N/R	12 ft	20 ft	31 ft	39 ft	78 ft
2000	N/R	N/R	N/R	16 ft	20 ft	40 ft
2400	N/R	N/R	N/R	13 ft	16 ft	32 ft
3000	N/R	N/R	N/R	10 ft	13 ft	26 ft

† N/R = Not Recommended. NOTE: Acceptable power is directly related to cable length (i.e. - the shorter the cable, the better the performance)

Use in conjunction with DC wiring connection instructions in the Battery Connection section.
Inverter/Charger DC Volt: 12

Note on Labeling Two symbols are used on the RV labels.
 V ~ ~ : AC Voltage V --- : DC Voltage

WARRANTY REGISTRATION
 Visit www.triplite.com/warranty to register the warranty of your new Tripp Lite product. You'll be automatically entered into a drawing for a chance to win a FREE Tripp Lite product!
 * No purchase necessary. Void where prohibited. Some restrictions apply. See website for details.

Limited Warranty

Tripp Lite warrants its Inverter/Chargers to be free from defects in materials and workmanship for a 30 month period from the date of retail purchase by end user. Tripp Lite's obligation under this warranty is limited to repairing or replacing (at its sole option) any such defective products. To obtain service under this warranty you must obtain a Returned Material Authorization (RMA) number from Tripp Lite or an authorized Tripp Lite service center. Products must be returned to Tripp Lite or an authorized Tripp Lite service center with transportation charges prepaid and must be accompanied by a brief description of the problem encountered and proof of date and place of purchase. This warranty does not apply to equipment which has been damaged by accident, negligence or misapplication or has been altered or modified in any way, including opening of the unit's casing for any reason. This warranty applies only to the original purchaser who must have properly registered the product within 10 days of retail purchase.
 EXCEPT AS PROVIDED HEREIN, TRIPP LITE MAKES NO WARRANTIES, EXPRESS OR IMPLIED, INCLUDING WARRANTIES OF MERCHANTABILITY AND FITNESS FOR A PARTICULAR PURPOSE. Some states do not permit limitation or exclusion of implied warranties; therefore, the aforesaid limitation(s) or exclusion(s) may not apply to the purchaser.
 EXCEPT AS PROVIDED ABOVE, IN NO EVENT WILL TRIPP LITE BE LIABLE FOR DIRECT, INDIRECT, SPECIAL, INCIDENTAL OR CONSEQUENTIAL DAMAGES ARISING OUT OF THE USE OF THIS PRODUCT. EVEN IF ADVISED OF THE POSSIBILITY OF SUCH DAMAGE. Specifically, Tripp Lite is not liable for any costs, such as lost profits or revenue, loss of equipment, loss of data, costs of substitutes, claims by third parties, or otherwise.
 Tripp Lite has a policy of continuous improvement. Specifications are subject to change without notice.



SAVE THESE INSTRUCTIONS!

This manual contains important instructions and warnings that should be followed during the installation, operation and storage of all Tripp Lite Inverter/Chargers.

Note: For Marine installations, please replace this page with the page titled "For Marine Applications Only" found in the Owner's Manual Addendum.

Location Warnings

- Although your Inverter/Charger is moisture resistant, it is NOT waterproof. Flooding the unit with water will cause it to short circuit and could cause personal injury due to electric shock. Never immerse the unit, and avoid any area where standing water might accumulate. Mounting should be in the driest location available.
- Leave a minimum of 2" clearance at front and back of the Inverter/Charger for proper ventilation. To avoid automatic Inverter/Charger shutdown due to overtemperature, any compartment that contains the Inverter/Charger must be properly ventilated with adequate outside air flow. The heavier the load of connected equipment, the more heat will be generated by the unit.
- Do not install the Inverter/Charger directly near magnetic storage media, as this may result in data corruption.
- Do not install near flammable materials, fuel or chemicals.

Battery Connection Warnings

- The Inverter/Charger will not operate (with or without utility power) until batteries are connected.
- Multiple battery systems must be comprised of batteries of identical voltage, age, amp-hour capacity and type.
- Because explosive hydrogen gas can accumulate near batteries if they are not kept well ventilated, your batteries should not be installed (whether for a mobile or stationary application) in a "dead air" compartment. Ideally, any compartment would have some ventilation to outside air.
- Sparks may result during final battery connection. Always observe proper polarity as batteries are connected.
- Do not allow objects to contact the two DC input terminals. Do not short or bridge these terminals together. Serious personal injury or property damage could result.

Equipment Connection Warnings

Do not use a Tripp Lite RV Inverter/Charger in life support or healthcare applications where a malfunction or failure of a Tripp Lite RV Inverter/Charger could cause failure of, or significantly alter the performance of, a life support device or medical equipment.

- You may experience uneven performance results if you connect a surge suppressor, line conditioner or UPS system to the output of the Inverter/Charger.
- Corded Models: Do not modify the Inverter/Charger's plug or receptacle in a way that eliminates its ground connection. Do not use power adapters that will eliminate the plug's ground connection.
- Connect your Inverter/Charger only to a properly grounded AC power outlet or hardwired source. Do not plug the unit into itself; this will damage the device and void your warranty.

Operation Warnings

- Your Inverter/Charger does not require routine maintenance. Do not open the device for any reason. There are no user serviceable parts inside.
- Potentially lethal voltages exist within the Inverter/Charger as long as the battery supply and/or AC input are connected. During any service work, the battery supply and AC input connection (if any) should therefore be disconnected.
- Do not connect or disconnect batteries while the Inverter/Charger is operating in either inverting or charging mode. Operating Mode Switch should be in the OFF position. Dangerous arcing may result.

Feature Identification

Identify the premium features on your specific model and quickly locate instructions on how to maximize their use.

- 1 Configuration DIP Switches:** optimize Inverter/Charger operation depending on your application. See Configuration section for setting instructions.
- 2 Operating Mode Switch:** controls Inverter/Charger operation. The “AUTO/REMOTE” setting ensures your equipment receives constant, uninterrupted AC power. It also enables the Inverter/Charger to be remotely monitored and controlled with an optional remote module (Tripp Lite model APSRM4, sold separately or included with select models). The “CHARGE ONLY” setting allows your batteries to return to full charge faster by turning the inverter off which halts battery discharging. See Operation section for setting instructions.
- 3 “LINE”, “INVERT”, “LOAD” LEDs:** intuitive “traffic light” signals show whether the Inverter/Charger is operating from AC line power or DC battery power. It also warns you if the connected equipment load is too high. See Operation section for instructions on reading the indicator lights.
- 4 “BATT VOLT/CHRG CURR” LEDs:** these three lights will turn ON in several sequences to show two separate operational conditions depending on the position of the Operating Mode Switch. See Operation section for instructions on reading indicator lights.
- 5 DC Power Terminals:** connect to your battery terminals. See Battery Connection section for instructions.
- 6 Ground Fault Interrupter (GFI) AC Receptacles (not on hardwire models):** allow you to connect equipment that would normally be plugged into a utility outlet. They feature ground fault interrupter switches that trip if there is excessive current on the ground safety wire.
- 7 AC Input Cord (not on hardwire models):** connects the Inverter/Charger to any source of utility- or generator-supplied AC power. See AC Input/Output Connection section for instructions.
- 8 Hardwire AC Input/Output Terminals (not on corded models):** securely connect the Inverter/Charger to vehicle or facility electrical system input and recommended GFI receptacle output. See AC Input/Output Connection section for instructions.
- 9 Resettable Circuit Breaker:** protect your Inverter/Charger against damage due to overload. See Operation section for resetting instructions.
- 10 Remote Control Module Connector:** allows remote monitoring and control with an optional module (Tripp Lite model APSRM4, sold separately or included with select models). See remote module owner’s manual for connection instructions.
- 11 Battery Charge Conservator (Load Sense) Dial (not on 612 models):** conserves battery power by setting the low-load level at which the Inverter/Charger’s inverter automatically shuts off. See Configuration section for setting instructions.
- 12 Main Ground Lug:** properly grounds the Inverter/Charger to vehicle grounding system or to earth ground. See Configuration section for instructions.
- 13 Multi-Speed Cooling Fan:** quiet, efficient fan prolongs equipment service life.
- 14 Hardwire AC Input/Output Cover Plate**
- 15 Battery Temperature Sensing Connector (not on 612 models):** prolongs battery life by adjusting charge based on battery temperature. Use with cable (included on select models). See Configuration section for details.
- 16 Automatic Generator Start Connector (not on 612 models):** automatically cycles generator based on battery voltage. Use with user-supplied cable. See Configuration section for details.

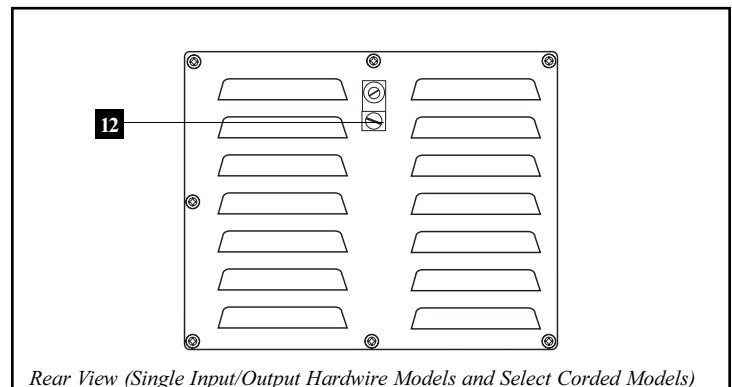
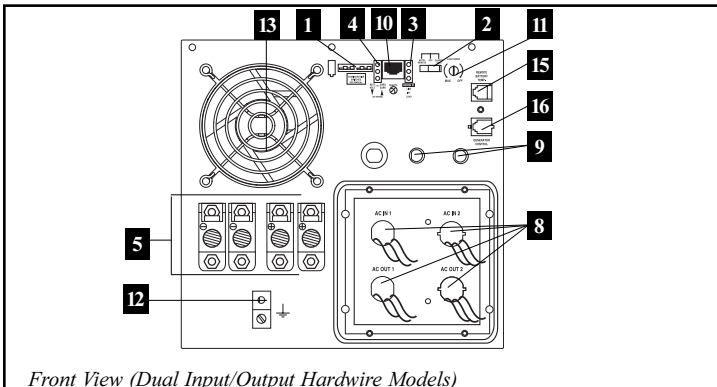
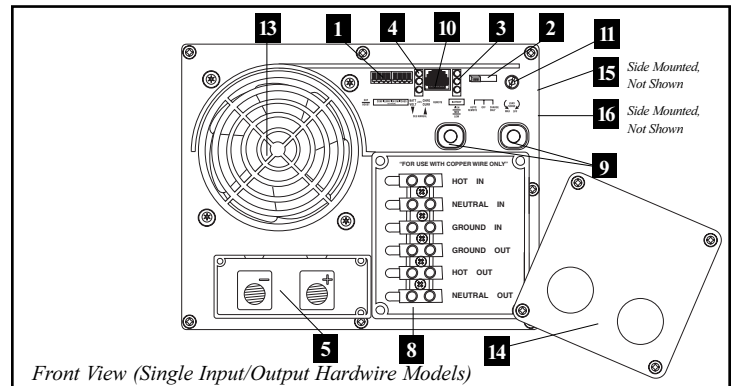
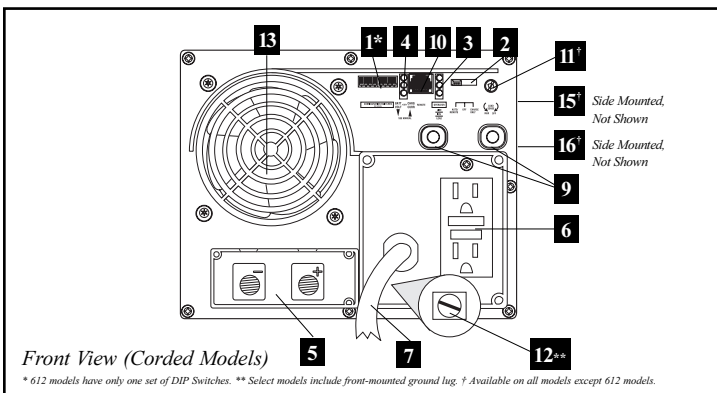

Switch Modes

After configuring, mounting and connecting your Inverter/Charger, you are able to operate it by switching between the following operating modes as appropriate to your situation:

AUTO/REMOTE: Switch to this mode when you need constant, uninterrupted AC power for connected appliances and equipment. The Inverter/Charger will continue to supply AC power to connected equipment and to charge your connected batteries while utility- or generator-supplied AC power is present. Since the inverter is ON (but in Standby) in this mode, it will automatically switch to your battery system to supply AC power to connected equipment in the absence of a utility/generator source or in over/under voltage situations. "AUTO/REMOTE" also enables an optional remote control module (Tripp Lite model APSRM4, sold separately or included with select models) to function when connected to the unit.

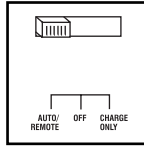

CHARGE ONLY: Switch to this mode when you are not using connected appliances and equipment in order to conserve battery power by disabling the inverter. The Inverter/Charger will continue to supply AC power to connected equipment and charge connected batteries while utility- or generator-supplied AC power is present. However, since the inverter is OFF in this mode, it WILL NOT supply AC power to connected equipment in the absence of a utility/generator source or in over/under voltage situations.

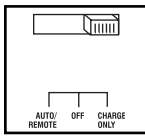

OFF: Switch to this mode to shut down the Inverter/Charger completely, preventing the inverter from drawing power from the batteries, and preventing utility AC from passing through to connected equipment or charging the batteries. Use this switch to automatically reset the unit if it shuts down due to overload or overheating. First remove the excessive load or allow the unit to sufficiently cool (applicable to your situation). Switch to "OFF", then back to "AUTO/REMOTE" or "CHARGE ONLY" as desired. If unit fails to reset, remove more load or allow unit to cool further and retry. Use an optional remote control module (Tripp Lite model APSRM4, sold separately or included with select models) to reset unit due to overload and overtemperature.

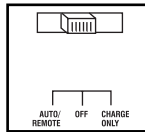

Indicator Lights

Your Inverter/Charger (as well as an optional Tripp Lite Remote Control Module, sold separately or included with select models) is equipped with a simple, intuitive, user-friendly set of indicator lights. These easily-remembered "traffic light" signals will allow you, shortly after first use, to tell at a glance a wide variety of operating details.

"LINE Green LED": If the operating mode switch is set to "AUTO/REMOTE", this light will ILLUMINATE CONTINUOUSLY when your connected equipment is receiving continuous AC power supplied from a utility/generator source.

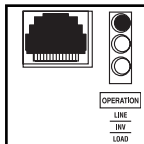

If the operating mode switch is set to "CHARGE ONLY", this light will BLINK to alert you that the unit's inverter is OFF and will NOT supply AC power in the absence of a utility/generator source or in over/under voltage situations.

"INV" (Inverting) Yellow LED: This light will ILLUMINATE CONTINUOUSLY whenever connected equipment is receiving battery-supplied, inverted AC power (in the absence of a utility/generator source or in over/under voltage situations). This

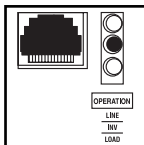

light will be off when AC power is supplying the load. This light will BLINK to alert you if the load is less than the Battery Charge Conservator (Load Sense) setting.

"LOAD" Red LED: This red light will ILLUMINATE CONTINUOUSLY whenever the inverter is functioning and the power demanded by connected appliances and equipment exceeds 100% of load capacity. The light will BLINK to alert you when the inverter shuts down due to a severe overload or overheating. If this happens, turn the operating mode switch "OFF"; remove the overload and let the unit cool. You may then turn the operating mode switch to either "AUTO/REMOTE" or "CHARGE ONLY" after it has adequately cooled. This light will be off when AC power is supplying the load.

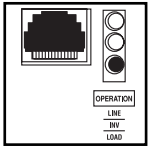

"BATT VOLT/CHRG CURR" LEDs: these three lights will turn ON in several sequences to show two separate operational conditions depending on the position of the Operating Mode Switch.

If the switch is in the "AUTO/REMOTE" position, the LEDs indicate the approximate charge level and voltage of your connected battery bank and alert you to several fault conditions. See Chart for charge and voltage levels.

If the switch is in the "CHARGE ONLY" position, the LEDs indicate the approximate charge rate of the Inverter/Charger. See Chart for charge rates. Note: the charge rates in the chart are expressed as percentages of the Inverter/Charger's rated charging amps, which vary by model. Refer to the Specifications to determine the charging amps of your specific model.

LED Function with Switch in "AUTO/REMOTE" Position

Approximate Battery Charge Level*

LEDs Illuminated	Battery Capacity (Charging/Discharging)
1 Green	91%–Full
2 Green & Yellow	81%–90%
3 Yellow	61%–80%
4 Yellow & Red	41%–60%
5 Red	21%–40%
6 All three lights off	1%–20%
7 Flashing red	0% (Inverter shutdown)**

* Charge levels listed are approximate. Actual conditions vary depending on battery condition and load. ** Inverter shutdown protects battery against damage due to excessive discharge.

Fault Condition

LEDs Illuminated	Fault Condition
1 All three lights flash slowly*	Excessive discharge (Inverter shutdown)
2 All three lights flash quickly**	Overcharge (Charger shutdown)

* Approximately 1/2 second on, 1/2 second off. See Troubleshooting section. Inverter shutdown protects battery against damage due to excessive discharge. ** Approximately 1/4 second on, 1/4 second off. Charger shutdown protects battery against damage due to overcharge. May also indicate a battery charger fault exists. See Troubleshooting section.

Operation *(continued)*

LED Function with Switch in "CHARGE ONLY" Position

Approximate Charge Rate Indication

LEDs Illuminated	Charge Rate
1 All three lights on	Overcharge error*
2 Red	75% - 100%
3 Red & Yellow	50% - 75%
4 Yellow	25% - 50%
5 Green	0% - 25%
6 All three lights off	0%

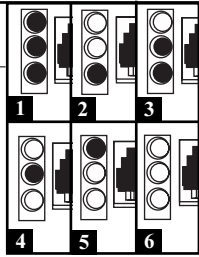

* If all three lights remain on, an internal fault may exist. Turn off and disconnect the unit. Then, call Tripp Lite at (773) 869-1234 for assistance.

Resetting Your Inverter/Charger to Restore AC Power

Your Inverter/Charger may cease supplying AC power or DC charging power in order to protect itself from overload or to protect your electrical system. To restore normal functioning:

Overload Reset: Switch operating mode switch to "OFF" and remove some of the connected electrical load (ie: turn off some of the AC devices drawing power which may have caused the overload of the unit). Wait one minute, then switch operating mode switch back to either "AUTO/REMOTE" or "CHARGE ONLY."

Output Circuit Breaker Reset: Alternatively, check output circuit breaker(s) on the unit's front panel. If tripped, remove some of the electrical load, then wait one minute to allow components to cool before resetting the circuit breaker. See Troubleshooting for other possible reasons AC output may be absent.

Configuration

Set Configuration DIP Switches

Using a small tool, set the Configuration DIP Switches (located on the front panel, see diagram) to optimize Inverter/Charger operation depending on your application. RV612UL and RV612ULH models include one set of four DIP Switches. All other models include an additional set of four DIP switches to configure additional operational functions. Refer to the appropriate section to review the instructions for your specific model.

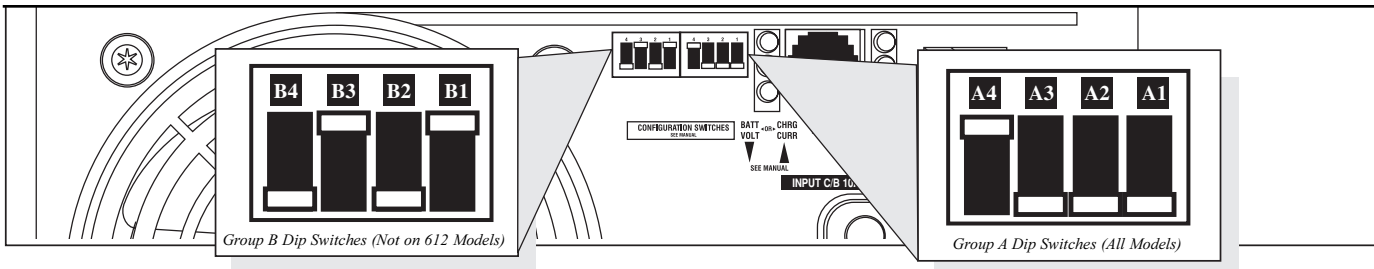

Group A DIP Switches (All Models)

Using a small tool, configure your Inverter/Charger by setting the four Group A DIP Switches (located on the front panel of your unit; see diagram) as follows:

A1 Select Battery Type—REQUIRED (All models)

CAUTION: The Battery Type DIP Switch setting must match the type of batteries you connect, or your batteries may be degraded or damaged over an extended period of time. See "Battery Selection," p. 10 for more information.



Battery Type	Switch Position
Gel Cell (Sealed) Battery	Up
Wet Cell (Vented) Battery	Down (factory setting)

A2 Select High AC Input Voltage Point for Switching to Battery—OPTIONAL* (All Models)

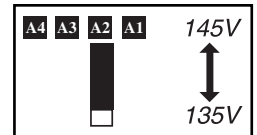

Voltage	Switch Position
145V	Up
135V	Down (factory setting)

* Most of your connected appliances and equipment will perform adequately when your Inverter/Charger's High AC Input Voltage Point (DIP Switch #2 of Group A) is set to 135V and its Low AC Voltage Input Point (DIP Switches #3 and #4 of Group A or DIP Switch #3 for 612 models) are set to 95V. However, if the unit frequently switches to battery power due to momentary high/low line voltage swings that would have little effect on equipment operation, you may wish to adjust these settings. By increasing the High AC Voltage Point and/or decreasing the Low AC Voltage Point, you will reduce the number of times your unit switches to battery due to voltage swings.

Configuration *(continued)*

All Models Except 612 Models

A4 A3 Select Low AC Input Voltage Point for Switching to Battery—OPTIONAL*

Voltage	Switch Position
105V	#A4 Up & #A3 Up
95V	#A4 Up & #A3 Down
85V	#A4 Down & #A3 Up
75V	#A4 Down & #A3 Down (factory setting)

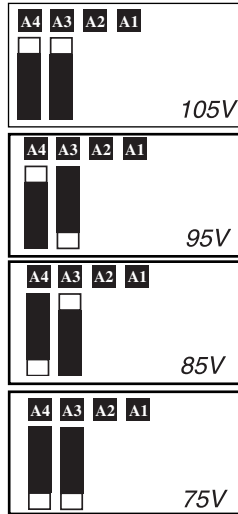

612 Models Only

A4 & A3 Settings

A3 Select Low AC Input Point for Switching to Battery—OPTIONAL

Voltage	Switch Position
105V	Up
95V	Down (factory setting)

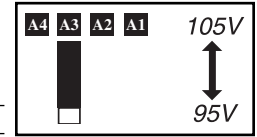

A4 Set Battery Charging Amps Type—OPTIONAL

Check specifications on for your unit's high- and low-charging amp options. By setting on high charging, your batteries will charge at maximum speed and your RV 12V DC system loads will be well-supplied. When setting on low charging, you lengthen the life of your batteries (especially smaller ones).

Battery Charger	Switch Position
High Charge Amp	Up (factory setting)*
Low Charge Amp	Down

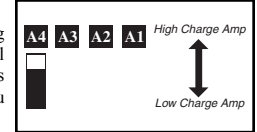

* RV612ULH models have the "A4" DIP Switch set in the up position (high charge amps). RV612UL models have the "A4" DIP Switch set in the down position (low charge amps).

* Most of your connected appliances and equipment will perform adequately when your Inverter/Charger's High AC Input Voltage Point (DIP Switch #2 of Group A) is set to 135V and its Low AC Voltage Input Point (DIP Switches #3 and #4 of Group A or DIP Switch #3 for 612 models) are set to 95V. However, if the unit frequently switches to battery power due to momentary high/low line voltage swings that would have little effect on equipment operation, you may wish to adjust these settings. By increasing the High AC Voltage Point and/or decreasing the Low AC Voltage Point, you will reduce the number of times your unit switches to battery due to voltage swings.

Group B DIP Switches (Not on 612 Models)

B1 B2 Select Load Sharing—OPTIONAL (Not on 612 Models)

Your Inverter/Charger features a high-output battery charger that can draw a significant amount of AC power from your utility source or generator when charging at its maximum rate. If your unit is supplying its full AC power rating to its connected heavy electrical loads at the same time as this high charging occurs, the AC input circuit breaker could trip, resulting in the complete shut off of pass-through utility power.

To reduce the chance of tripping this breaker, all RV Inverter/Chargers (except models RV612UL and RV612ULH) may be set to automatically limit the charger output. This keeps the sum of the unit's AC load and charge power within the circuit breaker rating. This charger-limiting function has four settings, allowing you to reduce the charger's draw lower and lower, as needed, if the AC input circuit breaker keeps tripping under the normal AC loads of devices you have connected downline from the unit. The figures show how to set your DIP Switches to determine how heavy the connected load can be on your Inverter/Charger before charger-limiting begins.

All Models, except RV612UL & RV612ULH*

Select Battery Charger-Limiting Points—OPTIONAL (Not on 612 Models)

"Most Limiting" (#B2 & #B1 Up): Charger-limiting takes effect the moment any 120V AC load is applied; charger output falls gradually from full output at no 120V load passing through to no output at full load.

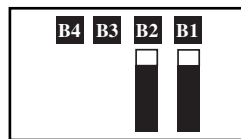

"Less Limiting" (#B2 Up & #B1 Down, factory setting for RV1012UL models): Charger-limiting begins when the Inverter/Charger's load reaches 33% of the Inverter/Charger's load rating. Charger output falls gradually from full output at 33% of the Inverter/Charger's load rating to about 40% of full output at full load.

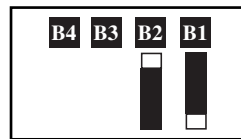

All Models, except RV612UL, RV612ULH & RV1012UL*

"Least Limiting" (#B2 Down & #B1 Up, factory setting for all models except RV1012UL): Charger-limiting begins when the Inverter/Charger's load reaches 66% of the Inverter/Charger's load rating. Charger output falls gradually from full output at 66% of the Inverter/Charger's load rating to about 40% of full output at full load.

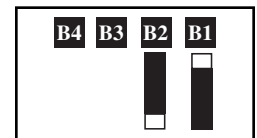

"No Limiting" (#B2 & #B1 Down): No charger-limiting occurs at any load size.

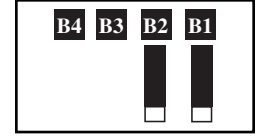

* NOTE! RV612UL & RV612ULH models do not include these DIP Switches. There are only two limiting points available for RV1012UL models—"Most Limiting" and "Less Limiting"—which are determined solely by the position of the B1 DIP Switch (either up or down). The B2 DIP Switch on these models has no effect.

Configuration *(continued)*

B3 Select Equalize Battery Charge—OPTIONAL (Not on 612 Models)

This DIP Switch is momentarily engaged to begin the process of equalizing the charge state of your battery's cells by time-limited overcharge of all cells. This can extend the useful life of certain types of batteries; consult with your battery's manufacturer to determine if your batteries could benefit from this process. The charge equalization process is automatic; once started, it can only be stopped by removing the input power.



Setting Procedure

- Move to “Equalize” (DOWN) position for three seconds.
- Move to “Reset” (UP) position and leave it there. This is the factory default setting.

CAUTION: Do not leave DIP switch #B3 in the down position after beginning process. Battery charge equalization should only be performed in strict accordance with the battery manufacturer's instructions and specifications.

Battery Charge	Switch Position
Reset	Up (factory setting)
Equalize	Down—momentarily

B4 Set Battery Charging Amps—OPTIONAL (function included on **A4** switch on 612 models)

Check specifications for your unit's high- and low-charging amp options. By setting on high charging, your batteries will charge at maximum speed and your RV 12V DC system loads will be well-supplied. When setting on low charging, you lengthen the life of your batteries (especially smaller ones).

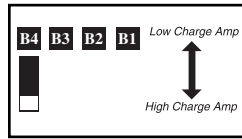

Battery Charger	Switch Position
Low Charge Amps	Up
High Charge Amps	Down (factory setting)

CAUTION: When switching to the High Charge Amp setting, the user must ensure that the amp hour capacity of their battery system exceeds the amperage of the High Charge Amp setting or the batteries may be damaged or degraded.

Set Battery Charge Conserver (Load Sense) Dial—OPTIONAL (Not on 612 models)

In order to save battery power, the unit's inverter automatically shuts off in the absence of any power demand from connected equipment or appliances (the electrical load). When the unit detects a load, it automatically turns its inverter function on. Users may choose the minimum load the Inverter/Charger will detect by adjusting the Battery Charge Conserver Dial (see diagram). Using a small tool, turn the dial clockwise to lower the minimum load that will be detected, causing the inverter to turn on for smaller loads. When the dial is turned fully clockwise, the inverter will operate even when there is no load. Turn the dial counterclockwise to increase the minimum load that will be detected, causing the inverter to stay off until the new minimum load is reached.

Note: the factory setting for the dial is fully clockwise. However, based on the threshold load to which you'd like the inverter to respond, you should adjust the dial counterclockwise to reduce its sensitivity until the inverter is active only when connected equipment or appliances are actually in use.

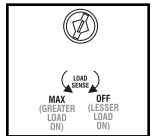

Connect Remote Control—OPTIONAL (All models)

All models feature an 8-conductor telephone style receptacle on the front panel for use with an optional remote control module (Tripp Lite model APSRM, sold separately or included with select models). The remote module allows the Inverter/Charger to be mounted in a compartment or cabinet out of sight, while operated conveniently from within the living area or control panel of your RV. See instructions packed with the remote control module.

Connect Battery Temperature Sensing Cable—OPTIONAL (not on 612 models)

The battery temperature sensing function prolongs battery life by adjusting the charge float voltage level based on battery temperature. Connect the sensor cable (the cable, included with select models, has an RJ style connector on one end and a black sensor on the other) to the RJ style jack located on the side of the Inverter/Charger labeled “Remote Temp. Sense.” With user-supplied electrical or duct tape, affix the sensor to the side of the battery below the electrolyte level. Make sure that nothing, not even tape, comes between the sensor and the side of the battery. To guard against false readings due to ambient temperature, place the sensor between batteries, if possible, or away from sources of extreme heat or cold. If the sensor cable is not used, the Inverter/Charger will charge according to its default 25° C values.

Utilize Automatic Generator Starter Capability—OPTIONAL (not on 612 models)

All models except 612 models include an RJ type modular jack on the side panel labeled “Generator Start”. Attach to vehicle generator ON/OFF switching mechanism with user-supplied cable (see Pin Configuration Diagram). Once attached, the interface will allow the Inverter/Charger to automatically switch a vehicle generator on when connected battery voltage levels are low (11.6 VDC) and switch it off when battery voltage levels are high (14.1 VDC).

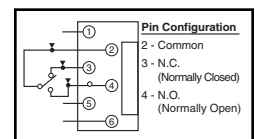

Battery Selection

Select Auxiliary Battery Type (if any)

Select "Deep Cycle" batteries to receive optimum performance from your Inverter/Charger. Do not use ordinary car or starting batteries or batteries rated in Cold Cranking Amps (CCA). If the batteries you connect to the Inverter/Charger are not true Deep Cycle batteries, their operational lifetimes may be significantly shortened. If you are using the same battery bank to power the Inverter/Charger as well as DC loads, your battery bank will need to be appropriately sized (larger loads will require a battery bank with a larger amp-hour capacity) or the operational lifetimes of the batteries may be significantly shortened.

Batteries of either Wet-Cell (vented) or Gel-Cell /Absorbed Glass Mat (sealed) construction are ideal. 6-volt "golf cart", Marine Deep-Cycle or 8D Deep-Cycle batteries are also acceptable. You must set the Inverter/Charger's Battery Type DIP Switch (see Configuration section for more information) to match the type of batteries you connect or your batteries may be degraded or damaged over an extended period of time. In many cases, the vehicle battery may be the only one installed. Auxiliary batteries must be identical to the vehicle batteries if they are connected to each other.

Match Battery Amp-Hour Capacity to Your Application

Select a battery or system of batteries that will provide your Inverter/Charger with proper DC voltage and an adequate amp-hour capacity to power your application. Even though Tripp Lite Inverter/Chargers are highly-efficient at DC-to-AC inversion, their rated output capacities are limited by the total amp-hour capacity of connected batteries and the support of your vehicle's alternator if the engine is kept running.

Example

Tools

300W	220W	20W	= 540W

Appliances

300W	140W	100W	= 540W

- **STEP 1: Determine Total Wattage Required**

Add the wattage ratings of all equipment you will connect to your Inverter/Charger. Wattage ratings are usually listed in equipment manuals or on nameplates. If your equipment is rated in amps, multiply that number times AC utility voltage to determine watts. (Example: a 1/4 in. drill requires 2 1/2 amps. 2 1/2 amps × 120 volts = 300 watts.)

Note: Your Inverter/Charger will operate at higher efficiencies at about 75% - 80% of nameplate rating.

- **STEP 2: Determine DC Battery Amps Required**

Divide the total wattage required (from step 1, above) by the battery voltage (12) to determine the DC amps required.

$$540 \text{ watts} \div 12\text{V} = 45 \text{ DC Amps}$$

- **STEP 3: Estimate Battery Amp-Hours Required** (for operation unsupported by the alternator)

Multiply the DC amps required (from step 2, above) by the number of hours you estimate you will operate your equipment exclusively from battery power before you have to recharge your batteries with utility- or generator-supplied AC power. Compensate for inefficiency by multiplying this number by 1.2. This will give you a rough estimate of how many amp-hours of battery power (from one or several batteries) you should connect to your Inverter/Charger.

NOTE! Battery amp-hour ratings are usually given for a 20-hour discharge rate. Actual amp-hour capacities are less when batteries are discharged at faster rates. For example, batteries discharged in 55 minutes provide only 50% of their listed amp-hour ratings, while batteries discharged in 9 minutes provide as little as 30% of their amp-hour ratings.

$$45 \text{ DC Amps} \times 5 \text{ Hrs. Runtime} \\ \times 1.2 \text{ Inefficiency Rating} = 270 \text{ Amp-Hours}$$

- **STEP 4: Estimate Battery Recharge Required, Given Your Application**

You must allow your batteries to recharge long enough to replace the charge lost during inverter operation or else you will eventually run down your batteries. To estimate the minimum amount of time you need to recharge your batteries given your application, divide your required battery amp-hours (from step 3, above) by your Inverter/Charger's rated charging amps (see Specifications section).

NOTE! For Tripp Lite Inverter/Chargers providing 1000 watts or less of continuous AC power, a full-size battery will normally allow sufficient power for many applications before recharging is necessary. For mobile applications, if a single battery is continuously fed by an alternator at high idle or faster, then recharging from utility or generator power may not be necessary. For Tripp Lite Inverter/Chargers over 1000 watts used in mobile applications, Tripp Lite recommends you use at least two batteries, if possible fed by a heavy-duty alternator anytime the vehicle is running. Tripp Lite Inverter/Chargers will provide adequate power for ordinary usage within limited times without the assistance of utility or generator power. However, when operating extremely heavy electrical loads at their peak in the absence of utility power, you may wish to "assist your batteries" by running an auxiliary generator or vehicle engine, and doing so at faster than normal idling.

$$270 \text{ Amp-Hours} \div 55 \text{ Amps} \\ \text{Inverter/Charger Rating} = 5 \text{ Hours Recharge}$$

Mounting



WARNING! Mount your Inverter/Charger BEFORE DC battery and AC power connection. Failure to follow these instructions may lead to personal injury and/or damage to the Inverter/Charger and connected systems.

Tripp Lite manufactures a variety of different Inverter/Chargers with a variety of different mounting options for use in vehicular or non-vehicular applications. Tripp Lite recommends permanent mounting of your Inverter/Charger in any of the configurations illustrated below. User must supply mounting hardware and is responsible for determining if the hardware and mounting surface are suitable to support the weight of the Inverter/Charger. Contact Tripp Lite if you require further assistance in mounting your Inverter/Charger.

612 Models Only

Whether mounted horizontally or vertically, the Inverter must be located in an enclosed compartment, shielded from outside weather conditions.

A Using the measurements from the diagram, install two user-supplied 1/4" (6 mm) fasteners into a rigid horizontal surface, leaving the heads slightly raised. **B** Slide the Inverter/Charger back over the fasteners to engage the mounting slots molded on the bottom of the Inverter/Charger cabinet. **C** Install and tighten two user-supplied 1/4" (6 mm) fasteners into the mounting feet molded on the front of the Inverter/Charger cabinet.

The polycarbonate cabinet and mounting feet of your Inverter/Charger are durable enough to allow for vertical mounting as well, if your vehicle compartment requires this configuration. For vertical mounting, the control panel of the Inverter/Charger should face up.

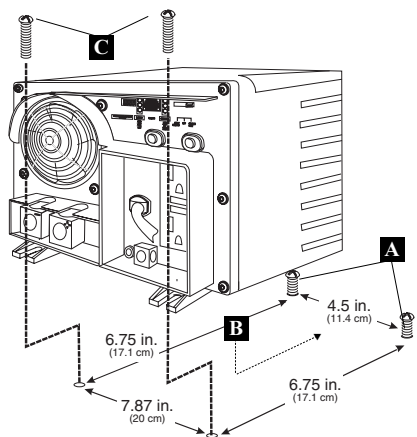

All Models Except 612 Models

Note: When operating RV1012UL and RV2012UL models in a marine application, refer to the accompanying marine owners' manual addendum.

Whether mounted horizontally or vertically, the Inverter must be located in an enclosed compartment, shielded from outside weather conditions.

A Using the measurements from the diagram, install two user-supplied 1/4" (6 mm) fasteners into a rigid horizontal surface, leaving the heads slightly raised. **B** Slide the Inverter/Charger forward over the fasteners to engage the mounting feet molded on the front of the Inverter/Charger cabinet. Install and tighten additional user-supplied 1/4" (6 mm) fasteners into the mounting feet molded on the rear and sides of the Inverter/Charger cabinet*. The rear feet extend beyond the unit's cabinet to provide for adequate ventilation space behind the cooling fan(s); they should not be removed.

The polycarbonate cabinet and mounting feet of your Inverter/Charger are durable enough to allow for vertical mounting as well, if your vehicle compartment requires this configuration. For vertical mounting, the control panel of the Inverter/Charger should face up.

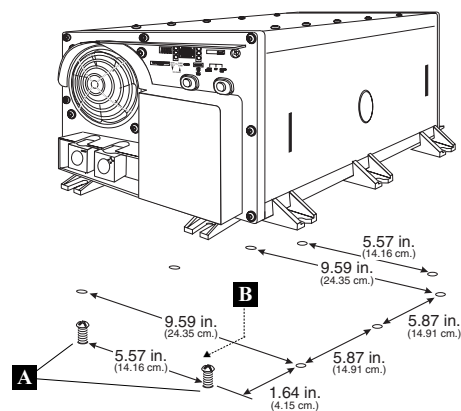

Note: RV model cabinets may have different front panel features, but all mount as per the figure above, or via the Lateral Mounting Bracket, illustrated at left.

* All models include front and rear mounting feet. Select models include side mounting feet.

Battery Connection

Connect your Inverter/Charger to your batteries using the following procedures:

• **Connect DC Wiring:** Though your Inverter/Charger is a high-efficiency converter of electricity, its rated output capacity is limited by the length and gauge of the cabling running from the battery to the unit. Use the shortest length and largest diameter cabling (maximum 2/0 gauge) to fit your Inverter/Charger's DC Input terminals. Shorter and heavier gauge cabling reduces DC voltage drop and allows for maximum transfer of current. Your Inverter/Charger is

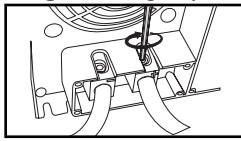

DC Connectors

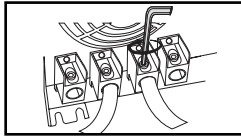

Dual DC Connectors (See note at bottom of the page)

capable of delivering peak wattage at up to 200% of its rated continuous wattage output for brief periods of time. See Specifications page for details. Heavier gauge cabling should be used when continuously operating heavy draw equipment under these conditions. Tighten your Inverter/Charger and battery terminals to approximately 3.5 Newton-meters of torque to create an efficient connection and to prevent excessive heating at this connection. Insufficient tightening of the terminals could void your warranty. See **Specifications page for Minimum Recommended Cable Sizing Chart.**

• **Connect Ground:** Using a #8 AWG wire or larger directly connect the Main Ground Lug to the vehicle's chassis or earth ground.

See the Feature Identification section to locate the Main Ground Lug on your specific Inverter/Charger model. All installations must comply with national and local codes and ordinances.

• **Connect Fuse:** NEC (National Electrical Code) article 551 requires that you connect all of your Inverter/Charger's positive DC Terminals directly to a UL-listed fuse(s) and fuse block(s) within 18 inches of the battery. The fuse's rating must equal or exceed the Minimum DC Fuse Rating listed in your Inverter/Charger's specifications. See Specifications for fuse and fuse block recommendations. See diagrams below for proper fuse placement.



WARNING! • Failure to properly ground your Inverter/Charger to a vehicle's chassis or earth ground may result in a lethal electrical shock hazard.

- Never attempt to operate your Inverter/Charger by connecting it directly to output from an alternator rather than a battery or battery bank.
- Observe proper polarity with all DC connections.

Vehicular

Your Inverter/Charger's Nominal DC Input Voltage **must match** the voltage of your battery or batteries—12 Volts in most vehicular applications.

It is possible to connect your Inverter/Charger to the main battery within your vehicle's electrical system. In most vehicles, the Inverter/Charger will be connected to one or more dedicated auxiliary (house) batteries which are isolated from the drive system to prevent possible draining of the main battery.

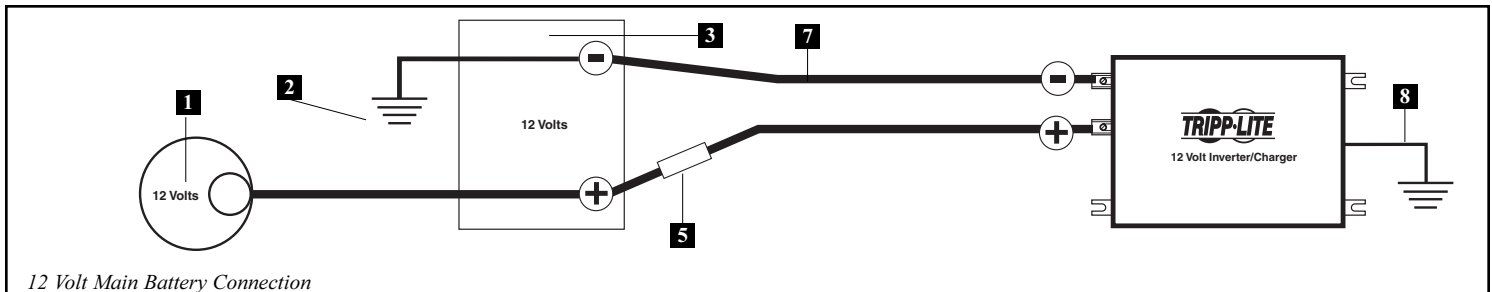

12 Volt Main Battery Connection

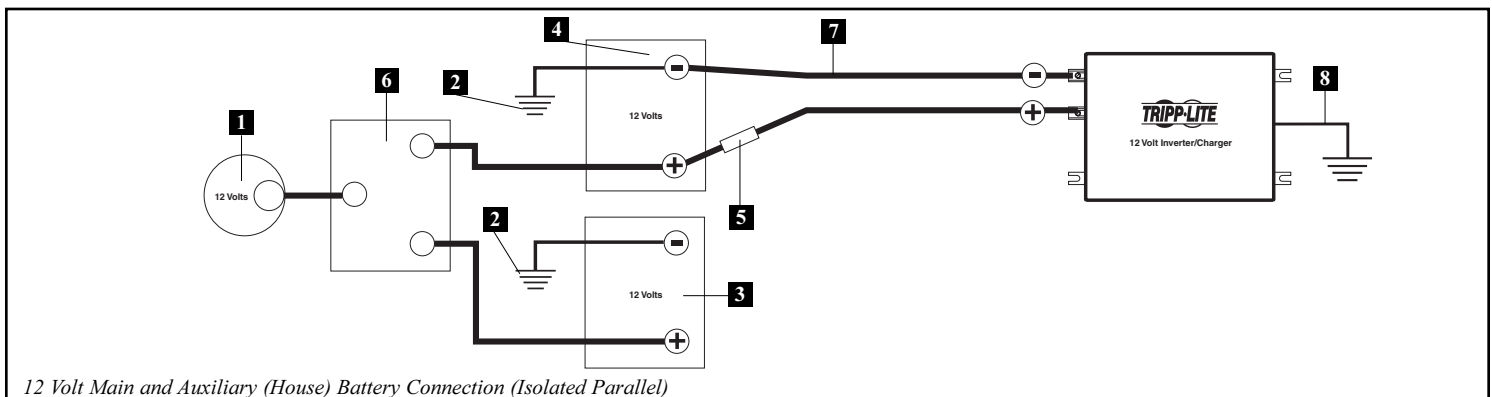

12 Volt Main and Auxiliary (House) Battery Connection (Isolated Parallel)

1 12 Volt Alternator **2** Vehicle Battery Ground **3** 12 Volt Main Battery **4** 12 Volt Auxiliary (House) Battery **5** UL-Listed Fuse & Fuse Block (mounted within 18 inches of the battery) **6** Battery Isolator **7** Large Diameter Cabling, Maximum 2/0 Gauge to Fit Terminals **8** 8 AWG (minimum) Ground Wire

NOTE: Select models include two positive and two negative DC terminals. Using the same connection architecture illustrated in the diagrams, run two 2/0 gauge cables from the Inverter/Charger's two negative terminals to the battery's single negative terminal; run two 2/0 gauge cables from the Inverter/Charger's two positive terminals, through two UL-listed fuses and fuse blocks, or equivalent, (one on each cable), to the battery's single positive terminal. Use the equivalent of two 2/0 cables in all other connections within the battery system. Connection to Two DC Terminals: It is acceptable to use two cables to connect your battery to only one positive and one negative DC terminal, however; your Inverter/Charger will provide reduced output power. It doesn't make a difference which positive and negative terminal you choose for the connection because both positive terminals are internally bonded and both negative terminals are also internally bonded. In this connection you must run one positive cable through one user-supplied UL-listed fuse and fuse block.

AC Input/Output Connection

To avoid overloading your Inverter/Charger, match the power requirements of the equipment you plan to run at any one time (add their total watts) with the output wattage capacity of your Inverter/Charger model (see Specifications). Do not confuse “continuous” wattage with “peak” wattage ratings. Most electric motors require extra power at start-up (“peak wattage”) than required to run continuously after start-up, sometimes over 100% more. Some motors, such as in refrigerators and pumps, start and stop intermittently according to demand, requiring “peak wattage” at multiple, unpredictable times during operation. DoubleBoost™ Feature: Tripp Lite Inverter/Chargers deliver up to twice their nameplate rated wattage for up to 10 seconds,* providing the extra power needed to cold start heavy-duty tools and equipment. OverPower™ Feature: Tripp Lite Inverter/Chargers deliver up to 150% of their name-plate rated wattage for up to 1 hour,* providing plenty of reserve power to reliably support tools and equipment longer.

* Actual duration depends on model, battery age, battery charge level and ambient temperature.

Connection for Models with Cords and Receptacles

Plug the Inverter/Charger’s AC input cord into an outlet providing 120V AC, 60Hz. power. Make sure that the circuit you connect your Inverter/Charger to has adequate overload protection, such as a circuit breaker or a fuse. Plug your equipment into the Inverter/Charger’s AC receptacles. Any equipment you connect to it will benefit from your Inverter/Charger’s built-in **ISOBAR®** surge protection!

 **Warning! Consult a qualified electrician and follow all applicable electrical codes and requirements for hardwire connection. Disconnect both DC input and AC utility supply before attempting hardwiring. Use wire type THHN or equivalent with minimum temperature rating of 90°C.**

Connection for Models with Hardwire Terminals

Output Connection Requirement: UL requires that the output terminals of all hard-wire Inverter/Charger models must be connected to UL-listed GFCI receptacles (required receptacle manufacturer/model series: Hubbell GF8300HGW or Leviton 6598).

Single Input/Output Models

Input: Connect incoming wires to the hot (brown) **2**, neutral (blue) **3** and ground* (green) terminals **1**.

Output: Connect outgoing wires to the hot (black) **4**, neutral (white) **5** and ground* (green) terminals **1**.

Replace cover plate and tighten screws. * If the incoming conduit only contains two wires (hot and neutral), the incoming conduit must be bonded to the main ground lug on the unit. In any case, the incoming conduit must be bonded to earth or vehicle ground, and the incoming conduit must be bonded to the outgoing conduit.

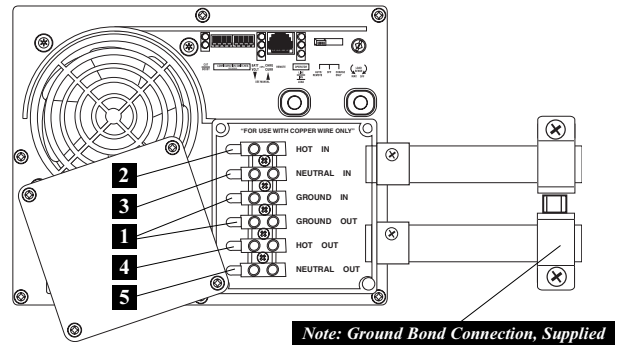

Dual Input/Output Models

Select models provide higher bypass power capacity by enabling connection of two separate AC input sources. These two sources can be either two 120V legs split from a single 240V service (with opposite phase on each 120V leg) or two different 120V sources. The Inverter/Charger will only supply 120V output power and WILL NOT provide 240V output even if it is connected to inputs from a split 240V service when in inverter mode. When the Inverter/Charger is receiving AC power, it can supply connected loads with up to 20 amps of power on each circuit**. When the Inverter/Charger is not receiving AC power, and has switched to inverting DC battery power, it can supply connected loads with various amperage levels (see “Maximum Output AC Current” in Specifications section) on BOTH circuits. Dual input/output models provide for either: a) dual-source inputs and outputs; b) single-source input and output; or c) single-source input and dual-source outputs (with AC OUT 2 power only available in invert mode). Connect user-supplied wire and conduit to the connections as follows:

Input: Connect incoming wires to hot (black for AC IN 1, black for AC IN 2), neutral (white for AC IN 1, white for AC IN 2) and ground (green/yellow) wires.

Output: Connect outgoing wires to hot (black for AC OUT 1, black for AC OUT 2), neutral (white for AC OUT 1, white for AC OUT 2) and ground (green/yellow) wires.

Dual-Source Input/Output*

- AC IN 1 will only provide line power to AC OUT 1.
- AC IN 2 will only provide line power to AC OUT 2.
- Inverted battery power is supplied to both AC OUT 1 and AC OUT 2.

Single-Source Input/Output*

- If you only have a single 120V AC input source, you must connect it to AC IN 1.
- If you only have a single output circuit, you must connect it to AC OUT 1

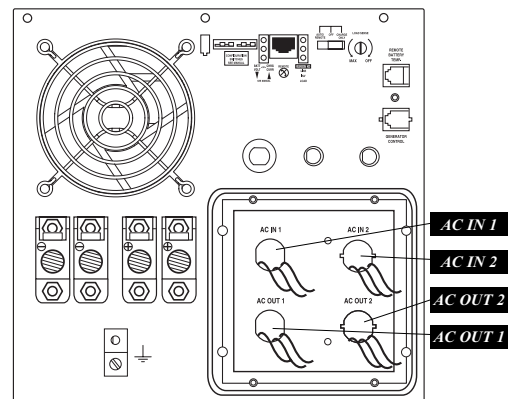

* Single-Source or Dual-Source Input/Output Connection: As well as supplying power to connected loads, AC IN 1 also provides power to the battery charger. If you connect a large load to AC OUT 1, you should select a more limiting battery charger setting (see “Select Battery Charger-Limiting Points”) or you may experience continual nuisance tripping of the electrical service (source) circuit breaker which supplies AC IN 1. The Inverter/Charger will only measure the current at AC OUT 1 to automatically limit the charger rate. AC IN 2 input current is passed through to AC OUT 2 without measurement. Single-Source Input/Dual-Source Output Connection: You may connect AC IN 1 and AC IN 2 to a single source to provide power to AC OUT 1 and AC OUT 2. However, the loads connected to AC OUT 2 will not be measured for the purpose of automatic charger limitation. This could result in occasional tripping of the electrical service (source) circuit breaker. If this occurs, reduce the load on AC OUT 2 until nuisance tripping stops.

** Load circuit breaker limited.

Service

Before returning your Inverter/Charger for service, follow these steps: 1.) Review the installation and operation instructions to ensure that the service problem does not originate from a misreading of the instructions. Also, check that the circuit breaker(s) are not tripped.* 2.) If the problem continues, do not contact or return the Inverter/Charger to the dealer. Instead, call Tripp Lite at (773) 869-1233. A service technician will ask for the Inverter/Charger's model number, serial number and purchase date and will attempt to correct the problem over the phone. 3.) If the problem requires service, the technician will issue you a Returned Material Authorization (RMA) number, which is required for service. Securely pack the Inverter/Charger to avoid damage during shipping. Do not use Styrofoam beads for packaging.** Any damages (direct, indirect, special, incidental or consequential) to the Inverter/Charger incurred during shipment to Tripp Lite or an authorized Tripp Lite service center is not covered under warranty. Inverter/Chargers shipped to Tripp Lite or an authorized Tripp Lite service center must have transportation charges prepaid. Mark the RMA number on the outside of the package. If the Inverter/Charger is within the warranty period, enclose a copy of your sales receipt. Return the Inverter/Charger for service using an insured carrier to the address given to you by the Tripp Lite service technician.

* This is a common cause of service inquiries which can be easily remedied by following the resetting instructions in this manual. ** If you require packaging, the technician can arrange to send you proper packaging.

Maintenance

Your Inverter/Charger requires no maintenance and contains no user-serviceable or replaceable parts, but should be kept dry at all times. Periodically check, clean and tighten all cable connections, as necessary, both at the unit and at the battery.

Troubleshooting

Try these remedies for common Inverter/Charger problems before calling for assistance. Call Tripp Lite Customer Service at (773) 869-1234 before returning your unit for service.

SYMPTOM	PROBLEMS	CORRECTIONS
No AC Output (All Indicator Lights are OFF)	Unit is not properly connected to utility power	Connect unit to utility power.
	Operating Mode Switch is set to "OFF" and AC input is present.	Set Operating Mode Switch to "AUTO/REMOTE" or "CHARGE ONLY".
	This is normal when the Operating Mode Switch is set to "CHARGE ONLY" and AC input is absent.	No correction is required. AC output will return when AC input returns. Set Operating Mode Switch to "AUTO/REMOTE" if you require AC output.
	Circuit breaker is tripped.	Reset circuit breaker.
	Unit has shut down due to battery overcharge (preventing battery damage). The problem may be with connected auxiliary chargers, if any, or with the unit's charger.	Disconnect any auxiliary chargers. Reset by moving Operating Mode Switch to "OFF". Wait 1 minute and switch to "AUTO/REMOTE" or "CHARGE ONLY." If unit remains in shutdown mode after several attempts to reset, contact Tripp Lite Customer Service for assistance.
	Unit has shut down due to excessive battery discharge.	Use an auxiliary charger* to raise battery voltage. Check external battery connections and fuse. Unit automatically resets when condition is cleared.
Battery Not Recharging (AC Input Present)	Unit has shut down due to overload.	Reduce load. Reset by moving Operating Mode Switch to "OFF". Wait 1 minute. Switch to "AUTO/REMOTE" or "CHARGE ONLY".
	Connected batteries are dead.	Check and replace old batteries.
	Battery fuse* is blown.	Check and replace fuse.*
	Battery cabling* is loose.	Check and tighten or replace cabling.*
	Unit has shut down due to battery overcharge (preventing battery damage). The problem may be with connected auxiliary chargers, if any, or with the unit's charger.	Disconnect any auxiliary chargers. Reset by moving Operating Mode Switch to "OFF". Wait 1 minute and switch to "AUTO/REMOTE" or "CHARGE ONLY." If unit remains in shutdown mode after several attempts to reset, contact Tripp Lite Customer Service for assistance.
All Three "BATT VOLT/CHRG CURR" LEDs are slowly flashing (½ second flashes) with Operating Mode Switch in the "AUTO/REMOTE" position.	Input circuit breaker is tripped.	Reset circuit breaker.
	Battery is excessively discharged. Unit will shut down to prevent battery damage.	Use an auxiliary charger* to raise battery voltage. Check external battery connections and fuse. Unit automatically resets when condition is cleared.
	Battery is overcharged. Unit will shut down to prevent battery damage. The problem may be with connected auxiliary chargers, if any, or with the unit's charger.	Disconnect any auxiliary chargers. Reset by moving Operating Mode Switch to "OFF". Wait 1 minute and switch to "AUTO/REMOTE." If unit remains in shutdown mode after several attempts to reset, contact Tripp Lite Customer Service for assistance.
Red "LOW" Battery Indicator Light is flashing with Operating Mode Switch in the "AUTO/REMOTE" position.	Battery voltage is low. Unit has shut down to protect battery from damage.	If AC power (utility- or generator-supplied) is present, the unit will automatically reset itself and start recharging connected batteries. However, if an external charger is used to recharge the batteries, you will need to manually reset the unit by moving the Operating Mode Switch to "OFF" for two seconds then returning it to "AUTO/REMOTE".
	False reading due to undersized or insufficiently connected DC cabling.	Use sufficient size DC cable sufficiently connected to Inverter/Charger.
Red "LOAD" Operation Indicator Light flashing	Inverter is overloaded. Unit will automatically shut down after 5 seconds.	Reduce load. Reset by moving Operating Mode Switch to "OFF". Wait 1 minute. Switch to "AUTO/REMOTE" or "CHARGE ONLY".

* User-supplied.



1111 W. 35th Street, Chicago, IL 60609 USA
773.869.1234 (USA) • 773.869.1212 (International)
www.tripplite.com